

**\* ALWAYS TEST THE UNIT ON SITE BEFORE INSTALLATION TO AVOID RE-STOCKING FEE \*** See full T&C's on our website

### 1 SIM Preparation

Ensure you read all instructions before continuing.

**The SIM cards provided need activated before use.** Follow the instructions provided or visit our telecoms website for more details:

[www.aesglobaltelecom.com](http://www.aesglobaltelecom.com)

Different networks use different APNs, and these must be set correctly for full operation. See Details overleaf on setting a new APN.

### 2 Site Wiring

**GSM Antenna**

**Intercom** (Install at desired height)

**DC Power Cable** (1.5mm<sup>2</sup> - 8m MAX)  
 Keep PSU as close to the unit as possible.

**PSU Enclosure** (Sold Separately)

### 4 Relay Connections

**Gate Controller**

**Driveway Gates**

**Relay 1**

**Relay 2**

**Optional Exit Button**

**Separate lock PSU**

**Magnetic Lock**

N/C  
COM  
N/O  
N/C  
COM  
N/O

N/C

### 3 Power

**DC24v IN**  
 (Polarity Protected)

### SITE SURVEY

**Please read this entire manual before installing this product. A full comprehensive manual is available on our website for additional information.**

Ensure there is good 4G signal on site. 4G units will fall back to 3G service in some countries.

Set up on a bench in workshop **BEFORE** going to site. Program the unit in the comfort of your work bench and call technical support should you have any questions.

This product requires a regular voice & SMS SIM card. **Do not use a data only SIM, as this will not work in the unit.** In order to make voice calls on a 4G system and get optimum service, your SIM and provider will need to offer VOLTE support (Voice over LTE).

### POWER CABLE

**KEEP POWER SUPPLY AS CLOSE AS POSSIBLE.**

**TIP:** Most technical calls received are due to installers using CAT5 or alarm cable to power the unit.

**NEITHER** are rated to carry enough power! ( 1.2amp peak )

*Please use the following cable:*

- Up to 2 metres ( 6 feet ) - Use minimum 0.5mm<sup>2</sup> ( 18 gauge )
- Up to 4 metres ( 12 feet ) - Use minimum 0.75mm<sup>2</sup> ( 16 gauge )
- Up to 8 metres ( 24 feet ) - Use minimum 1.0mm<sup>2</sup> ( 14 gauge )

**Power Consumption:**  
 Standby = 80mA  
 Calling Out = 300mA

### INGRESS PROTECTION

We recommend sealing all entry holes for prevention of insects that can cause issues with a risk of shorting out components.

To maintain the IP55 rating please follow the sealing instructions included. (also available online)

**LIGHTNING PRONE AREAS MUST USE SURGE PROTECTION FOR POWER SUPPLY!**

See overleaf for more PCB details  
**Turn Over**



### NEED MORE ASSISTANCE?

+44 (0)288 639 0693

SCAN THIS QR CODE TO BE BROUGHT TO OUR RESOURCES PAGE.

VIDEOS | HOW-TO GUIDES | MANUALS | QUICK START GUIDES

EXTRA RESOURCES

# CellCOM Prime 7 - Advanced GSM Intercom



**STILL HAVING TROUBLE?**  
 Find all of our support options such as Web Chat, Full Manuals, Customer Helpline and more on our website:  
[WWW.AESGLOBALONLINE.COM](http://WWW.AESGLOBALONLINE.COM)

\* ALWAYS TEST THE UNIT ON SITE BEFORE INSTALLATION TO AVOID RE-STOCKING FEE \* See full T&C's on our website

## Wiring Connections



**Tip:** Keypad and Prox are only available on selected models

**Tip:** All main connections are pre-wired. Below are optional wiring additions for 3<sup>rd</sup> party controllers.

**PCB Status LEDs**

- SOLID RED = PCB POWERED ON
- SOLID RED + BLUE FLASHING = SEARCHING
- SOLID RED + BLUE FLASHING + GREEN FLASHING = SUCCESSFULLY CONNECTED

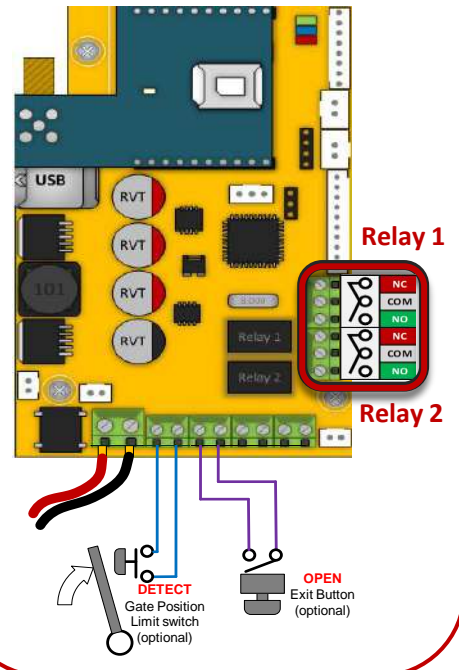

**Tip:** See the full manual for more detail on slave connections

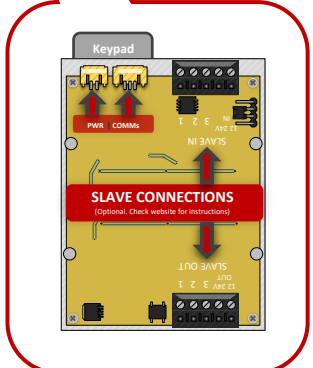
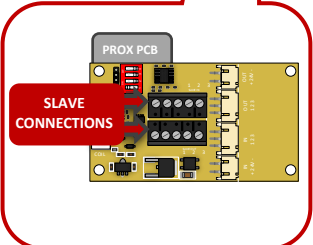

## SIM ORIENTATION

**ALWAYS** ensure the system is switched **OFF** when adding or removing your SIM card and ensure the orientation is correct.

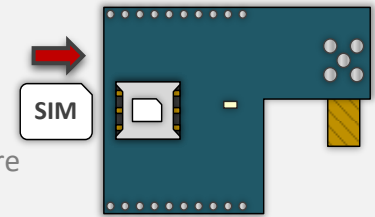

## CONNECTION TO NETWORK

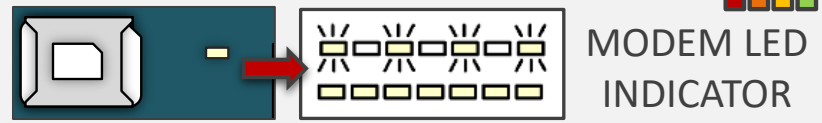

**4G:** Quick Flashing = Standby | Constant ON/OFF = Searching

## CHANGE APN (for VoLTE / 4G services)

The system will arrive with an AES multi-network SIM and will be pre-programmed with the APN to suit. If you wish to use a different SIM then the correct APN must be set for full operation.

Check with your network provider for the correct APN for 4G data. Once you have confirmed the APN enter it in place of 'APNinfo' in an SMS to the intercom.

via SMS  
 (if connected to network)

Ensure the PCB is powered on and connected to the network with a GREEN flashing LED. Then send the below text as an SMS to the intercom Sim number. A power reboot is required after the 'OK' reply message is received back.

via Keypad (if no 3G signal)  
 Contact Technical Support or check our resource page for a list of the APN serial number.

1. Power off the unit, then press and hold the call button and power the unit on again.
2. Upon power up, a long tone will be emitted from the speaker and the blue LED will remain solid - it is now in the APN setting mode.
3. After this, enter the APN serial number through the keypad then press #. (e.g. if you want to set APN No. 18, press 1 - 8, then #. A long beep will again be heard).
4. Reboot unit.

**9999#97APNinfo#**

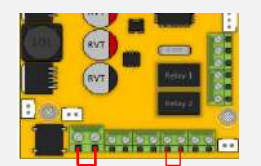
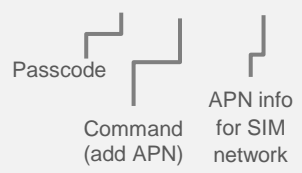

## ALTERNATIVE WIRING EXAMPLE

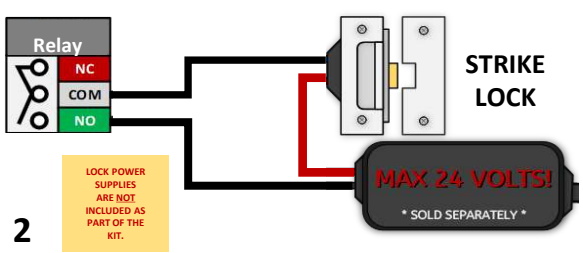

## ALTERNATIVE WIRING EXAMPLE

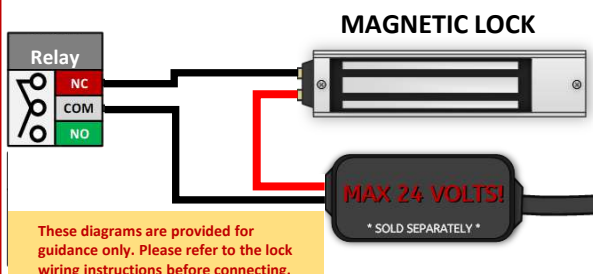

\* ALWAYS TEST THE UNIT ON SITE BEFORE INSTALLATION TO AVOID RE-STOCKING FEE \* See full T&C's on our website



**1** Download the App and Accept all permissions when the app is opened



## Getting Started

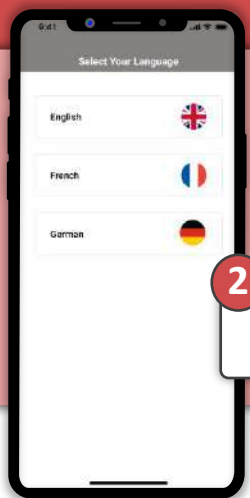

**2** Choose your language

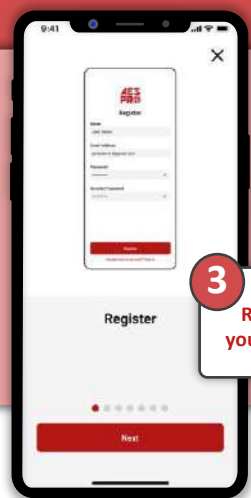

**3** Register your details

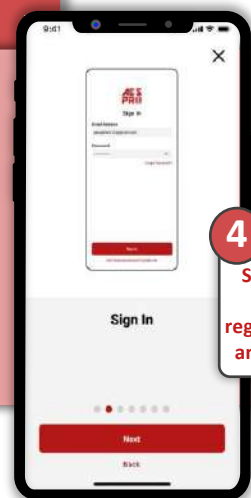

**4** Sign in using previously registered email and password

## Device Setup

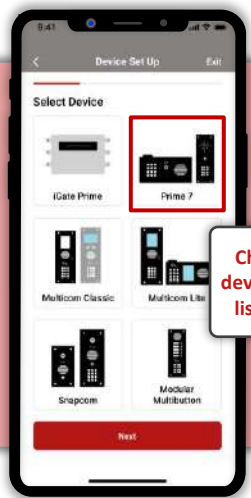

Choose your device from the list provided

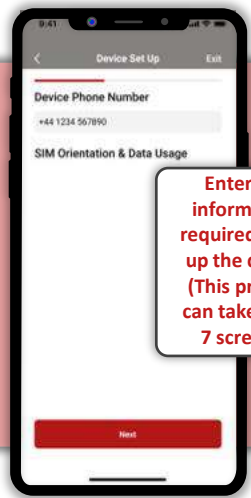

Enter the information required to set up the device (This process can take up to 7 screens)

## Additional App Configuration/Help

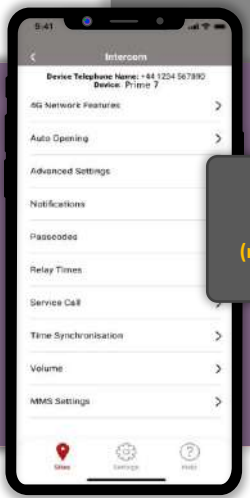

Customise Advanced Features (more on this on pg4)

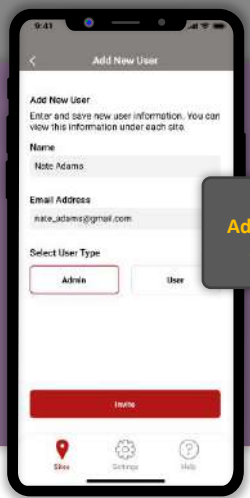

Add additional app users

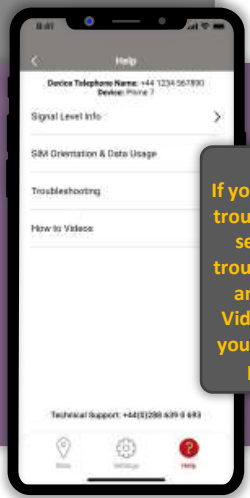

If you are having trouble the help section has troubleshooting and How to Videos to help you resolve the problem

\* ALWAYS TEST THE UNIT ON SITE BEFORE INSTALLATION TO AVOID RE-STOCKING FEE \* See full T&C's on our website

## Advanced Programming Setup



See our YouTube Channel for full app walkthrough



**SCAN ME**  
(Hold phone camera over the QR code)  
or search "AES Global"

**Note:** You need to send the SMS message created by the app to the intercom SIM number and receive the 'OK' reply for correct programming.



This QR code will take you to our resource page where you can find the datasheet for your intercom.

EXTRA RESOURCES

## INFORMATION (SMS Reply Examples)

**\*20#**

Firmware: Cellcom Prime v2.1.2  
Network mode: 4G  
Date: 18/12/21  
Signal level: 18  
APN:

**SIGNAL STRENGTH**  
Will reply with signal range 1-31. Min signal level should be 10 on 4G systems

**\*21#**

O11:987654321  
O12:123456789  
I1:987654321  
I2:123456789  
I3:5559991234  
I4:99955598767

**STORED NUMBERS**  
O=Dial out number.  
I=Dial IN Caller ID number.  
N = Another message to follow  
E = End of messages

**\*22#**

Open  
Relay1=OFF  
Relay2=OFF

**RELAY STATUS**  
OPEN - Shows status of the input terminals called DETECT - Can be used with a limit switch. Relay status shown to check if any relay is latched.

**\*23#**

0930-05/06/21-code=XX34-R1  
1345-05/06/21-CID-5432.10  
2034-04/06/21-user-55987  
1632-04/06/21-code=XX89-R2  
1244-04/06/21-code=XX98-R2  
0840-04/06/21-CID-995555  
2109-03/06/21-code=XX34  
2101-03/06/21-code=XX89-R2

**ACTIVITY LOG**  
Use this to see who used the intercom and when. Which pin codes were used, who used caller ID, who answered the call.  
**TIP:** Time and date is in international military format.

Last 6 digits of caller ID user phone number

Last 2 digits of keypad code used

**1234#25#**

Norm:1234,5555,6565,4321  
Temp:4545,7878,9876  
Plan:1010,4343

**STORED KEYPAD CODES**  
NORM=Permanent codes.  
TEMP=Temporary codes.  
PLAN=Time restricted codes.

**1234#26#**

Norm:6897254836R1,6548974581R2  
Temp:6989874154R1,6989977415R1  
Plan:6985332154R1

**STORED PROX ID CODES**  
NORM=Permanent codes.  
TEMP=Temporary codes.  
PLAN=Time restricted codes.

\* ALWAYS TEST THE UNIT ON SITE BEFORE INSTALLATION TO AVOID RE-STOCKING FEE \* See full T&C's on our website

## Using App for End User to Manage Gates



- Trigger**  
Send trigger command (Call / SMS)
- Latch**  
Hold open Gate / Door [SMS]
- Unlatch**  
Release held open gates to close. [SMS]

## Receiving A Call and Opening Gates / Door

Visitors can press the call button, which will initiate a call from your intercom to the designated phone numbers which will have been programmed by your installer.

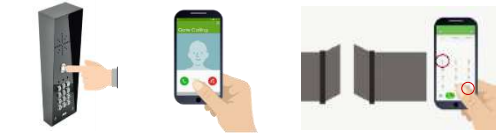

1. Press call button
2. Intercom calls up to 4 phones in sequence
3. Answer the call, speak to visitor, and grant access with phone keypad.

### Output 1

This is usually main gate/door.  
**Press 1# to open**  
 Press 2# to hold open  
 Press 3# to un-hold

### Output 2

This can be pedestrian gate, lights or other.  
**Press 4# to open**  
 Press 5# to hold open  
 Press 6# to un-hold

## INTERCOM MAINTENANCE

Bug ingress is a common issue in unit failures. Ensure that all components are sealed accordingly and check occasionally. **(Do not open the panel in the rain / snow unless correctly equipped to keep the internals dry. Ensure the unit is securely closed after maintenance)**

## SIM MAINTENANCE

If using a pre-pay casual SIM card it will need topped up occasionally. It is recommended to advise the home owner / end user to register the SIM card on the provider's web site if available. Most major networks allow registration of card payment details for an auto top up feature, which means they will automatically top up your intercom when the balance runs low or in some cases, they offer a low balance reminder to be sent if they do not wish the auto top up feature.

## ENVIRONMENTAL INFORMATION

The equipment that you bought has required the extraction and use of natural resources for its production. It may contain hazardous substances for the environment. In order to avoid the dissemination of those substances in our environment and to diminish the pressure on the natural resources, we encourage you to use the appropriate take-back systems. Those systems will reuse or recycle most of the materials of your end-of-life equipment.



The crossed-bin symbol marked in your device invites you to use those systems.

If you need more information on the collection, reuse and recycling systems, please contact your local or regional waste administration. You can also contact AES Global Ltd for more information on the environmental performances of our products.

## WARRANTY

Please note, by installing this product, you are accepting the following warranty terms:

1. The manufacturer's warranty is a "return to base" 2 year warranty from date of manufacture. This means that any suspected defective components or items are returned to the manufacturer's agent for investigation and diagnosis and returned at the cost of the customer.
2. The warranty does not cover, nor is the manufacturer or agent responsible for any of the following whatsoever: Storm damage, lightning or surge damage, flooding, accidental damage, vandalism or deliberate damage, un-explained corrosion or unusually harsh environments, failure of telephone networks, future un-interoperability between the product and network providers which cause malfunction due to changes implemented by the phone providers after manufacture of the product, or that which is outside of control of the manufacturer (e.g. 2G, 3G switch off, removal or inability to obtain VOLTE service), and damage due to inaccurate installation.
3. The manufacturer in no way accepts liability for any of the following incurred due to a product defect: Cost of attending site, inconveniences, labor rates, time lost, loss to or damage to property, security breaches, late payment clauses or breaches of any contracts between the installer and the client.
4. This is a professional install product only. The product is a component of an overall system. Therefore, it is the responsibility of the installer to certify the safety and compliance of the overall finished system. As soon as this product is fixed to another item, or connected to another third-party device, then the product has been modified, and compliance with local regulations in the country of install is strictly the responsibility of the installer.
5. Re-stocking fees may apply to items returned that are found to be non-defective. Complete units will also attract a re-stocking fee if returned for credit, regardless if a defect is discovered or not. Re-stocking fees may vary depending on the condition of the item being returned, and whether it can be determined as in brand new condition. The warranty terms do not entitle customers to an automatic full refund. For more details on returns procedures and re-stocking fees, contact the agent.
6. Items with physical signs of surge damage are not covered by warranty. Items with visible signs of surge damage will only be covered by warranty if photographic evidence is provided from site, showing surge protection has been installed.

Full warranty terms and conditions available upon request to AES Technical Department.

## Basic SMS Strings to Manage Gates

Function	CMD String (SMS)
<b>Manually trigger, latch or unlatch relay by SMS.</b> X = Relay Function. (1 = Trigger relay 1, 2 = Latch relay 1, 3 = Unlatch relay 1) (4 = Trigger relay 2, 5 = Latch relay 2, 6 = Unlatch relay 2)	1234#X#
<b>Check Intercom Status</b> (min signal level required for full operation is 10)	*20#
<b>Check Stored Numbers</b> O = Dial out number. I = Dial in number. N = Another message. E = End of messages.	*21#
<b>Check Relay Status</b>	*22#
<b>Events Log (check last 20 events, most recent first)</b> USER = dial out call made; CID = caller ID used; CODE = keypad code used; CARD = prox card / tag used. (UK date format).	*23#
<b>Check Stored Keypad Codes</b> Norm = permanent keypad codes; Plan = time restricted keypad codes; Temp = temporary keypad codes.	1234#25#
<b>Check Stored Prox Cards / Tag IDs</b> Norm = permanent prox card / tags; Plan = time restricted prox card / tags; Temp = temporary prox card / tags.	1234#26#
<b>Store Dialling Out Numbers (max 4)</b> X = 1-4 (sequence number dialled) Number = Phone number (max 14 characters)	9999#11Xnumber#
<b>Add Caller ID Number (max 250)</b> (14 digits maximum)	9999#72number#
<b>Add Keypad Code (max 250)</b> X = 1 or 2 (relay 1 or 2) Code = 4 digit passcode. Time = 1-9999 seconds, 0 for latching code.	9999#81Xcode#time#
<b>Add Prox Cards / Tag IDs (max 250)</b> X=1 or 2 for relay 1 or 2. Card ID = Prox ID number (fixed 10 digits) Time = 1-9999 seconds, or 0 for latching code. Name = Name of cardholder (max 6 characters)	9999#61XcardID#time#name#
<b>Change Relay Time</b> Time = 1-99 seconds	9999#50time#
<b>Enable Latching via DTMF (Disabled by Default)</b> X = 0 or 1 (0 = Disable, 1 = Enable)	9999#95X#
<b>Factory Reset (Default Everything)</b>	9999#999#

\* ALWAYS TEST THE UNIT ON SITE BEFORE INSTALLATION TO AVOID RE-STOCKING FEE \* See full T&C's on our website

## TROUBLESHOOTING

Symptoms caused	Problem/error	Solution
No LEDs on.	The unit will not power up.	Check power supply voltage at intercom is 23.4v DC or more. Cable length from PSU to intercom should be less than 25 feet and in 14 gauge for longer distances. See guide. Check the fuse.
No green CPU light	The unit powers up but is not showing network reception or will not respond to SMS.	A. This means the unit is not able to detect the network for some reason. -Power off the unit, remove the SIM and check it in a mobile phone to verify it can make a call and has calling credit if it is a Pay As You Go SIM. -Disable any PIN code request if active on the SIM card. -Check the SIM is a standard voice capable SIM. If you are unsure, contact your SIM card provider to verify. -Check the reception is medium or good. Poor reception is not sufficient. -Power off, remove the SIM, use fine sand paper to lightly sand the SIM pads and contacts on the GSM unit, lightly bend the contacts upwards so that they make better contact with the SIM and try again. -Check antenna is connected and does not have too many sharp bends on the antenna cable. -Check the height of the antenna and make sure it is not inside a metal enclosure. -Check correct power cable size for cable length from PSU. Refer to manual for guidelines
Call is going to voicemail if not answered.	The unit calls the first number, but voicemail comes on before it can ring the second number.	Decrease the calling time as per programming instructions.
The caller ID function does not work.	Incorrect programming or poor signal	If your number is a private or number withheld, then it will not work. -Ensure the number is programmed as you would normally dial it from another phone. - Ensure you have adequate GSM signal at the intercom by sending *20# as a test.
There is no audio from the gate, but the person at the gate can hear ok.	This can be due to low reception or excessively long power cables or underspec power cables.	-Check reception level by *20#. -Change SIM card if necessary, to another network which may have better coverage. -Purchase a high gain antenna. This may also be caused by a defective microphone, water on a microphone from a sprinkler for example, or dirt/insects blocking the microphone hole. If reception is optimum and the problem persists, contact your supplier or installer.
The audio quality that can be heard on the remote telephone is poor or humming (buzzing).	Poor reception or underspec power cables.	A small amount of GSM buzz can be considered normal on GSM intercoms, but not so much that causes inability to hear the person speaking. This is a symptom of poor reception. Try above steps on checking and improving reception. Consider fitting an external high gain antenna. Move the antenna further away. Remove any short bends in the antenna. Ensure the spare antenna cable is not rolled up inside the call station.
The trigger keys do not work when the intercom calls a phone.	Poor GSM signal at the gate or issue with gate control PCB	A. Check if you can hear the relay clicking at the gate when the keys are pressed during a call. If it can be heard, then the system is working, check wiring between the relay and the lock or gate panel. If the relays do not make a clicking sound, then check this feature on a different mobile cell phone or landline. If it works on a different phone, check the settings on the phone in question under DTMF tones. Failure of DTMF tones to operate correctly is also a symptom of low reception or insufficient power cabling. Check steps above on improving reception or addressing the power problem. -Also check that the relays are not already latched with the *22# command. If they are latched, they need unlatched before the trigger keys will work. -Check if it works by SMS. Try latching a relay then use the status button to check if the relay is latched. If that works, problem could be the phone being used, or low signal strength at the intercom.

## Reset / Default Unit

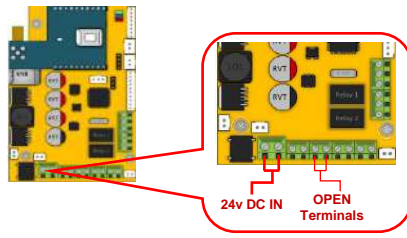

- 1) Power off the unit. (approx 60 secs)
- 2) Make a link across the terminals marked OPEN.
- 3) Switch on power
- 4) After several seconds the relay will click.
- 5) The unit will then clear memory and be defaulted
- 6) Remove the link and wait around 20 seconds.

**Note:** Performing this process will remove all current programming including saved users & access codes.

Manufacturer: Advanced Electronic Solutions Global Ltd  
 Address: Unit 4C, Kilcronagh Business Park, Cookstown, Co Tyrone, BT809HJ, UK

Complies with the following essential requirements for 2014/53/EU:  
 ETSI draft EN 301 489-1 V2.1.1 (2017-02) (Electromagnetic compatibility)  
 ETSI draft EN 301 489-52 (2016-11) (Electromagnetic compatibility, specific to cellular) (2G bands 900/1800, 3G band 1, 8 LTE bands 1, 3, 7, 8, 20).  
 Test report number LCS181101028AEA  
 ETSI EN 301 511 V12.5.1 (2017-03) (3.2 of directive 2014/53/EU)  
 ETSI TS 151 010-1 V12.8.0 (2016-05) (Digital cellular telecoms compliance)  
 Test report number LCS181101028AEB  
 ETSI EN 301 908-1 V11.1.1 (2016-07) (IMT Cellular networks, 3.2 of directive 2014/53/EU)  
 ETSI EN 301 908-2 V11.1.2 (2016-07) (CDMA spread / UTRA FDD)  
 Test report number LCS181101028AEC  
 ETSI EN 301 908-13 V11.1.2 (2017-07) (E-UTRA and UE standards)  
 Test report number LCS181101028AED  
 EN 62311 :2008 (Electromagnetic safety and human exposure)  
 Test report number: LCS181101028AEE  
 EN 60950-1, (A1, A11, A12, A2)  
 EN 62311  
 IEC 60950 (IT equipment safety)  
 Test report number: LCS181101029AS



The notified body is: Microm Labs (CAB number 2280).  
 This declaration is issued under the sole responsibility of the manufacturer.  
 Signed by:

Paul Creighton, Managing Director. Date: 4th Dec 2018

*This product is not a complete product until fully installed. It is therefore considered a component part of an overall system. The installer is responsible to check that the end installation complies with local regulatory requirements. This equipment forms part of a "fixed installation".*

**STILL HAVING TROUBLE?**  
 Find all of our support options such as Web Chat, Full Manuals, Customer Helpline and more on our website:

[WWW.AESGLOBALONLINE.COM](http://WWW.AESGLOBALONLINE.COM)  
 +44 (0)288 639 0693